

# REQUARTH MOULDING

CUSTOM MOULDING CATALOG  
MILLED TO ORDER

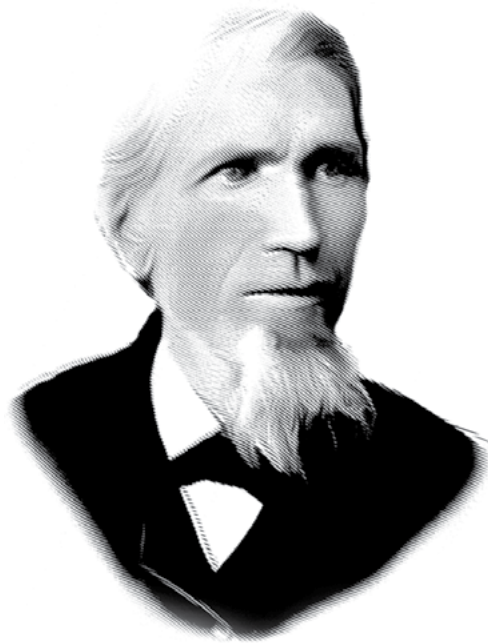

FREDERICK AUGUST REQUARTH  
*Founded the Requarth Co. 1860*

937-224-1141

**REQUARTH Co.**  
Est. 1860  
LUMBER, MILLWORK & KITCHENS

# Base

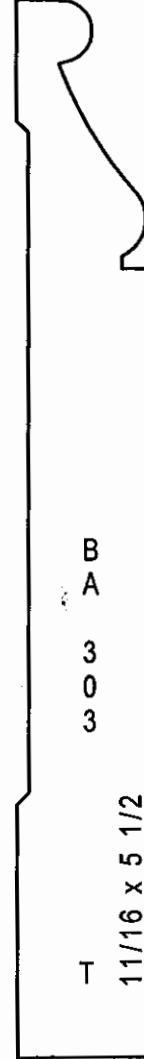
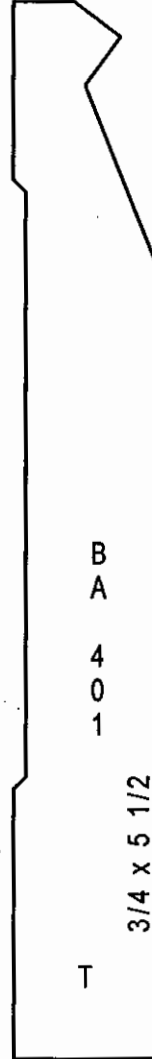
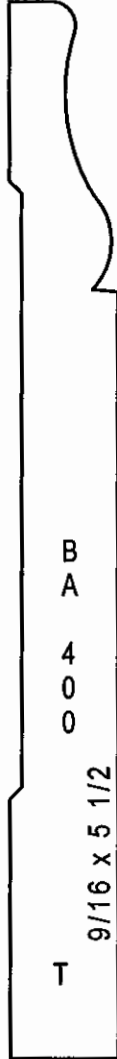
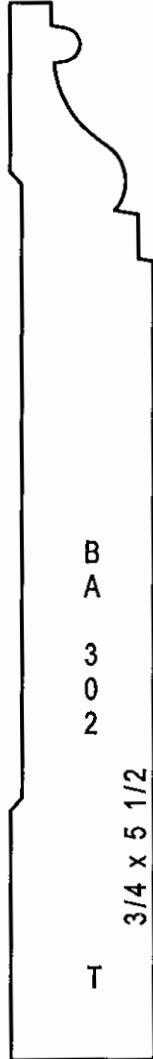
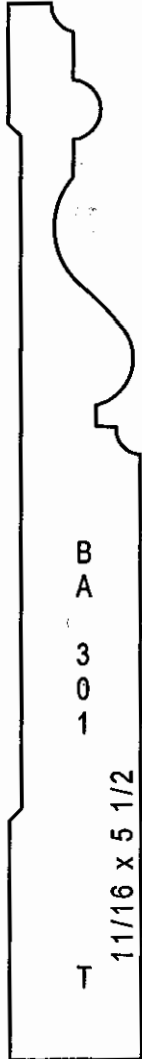
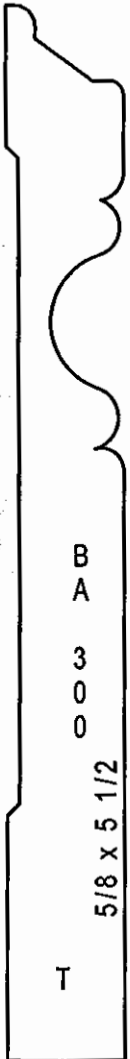
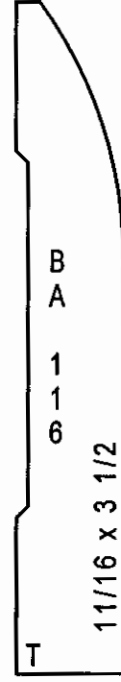
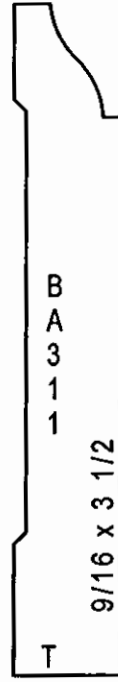
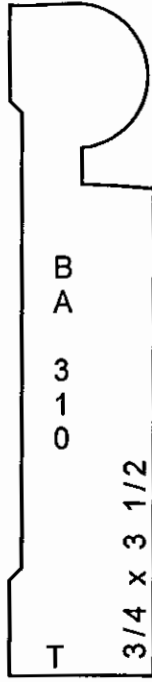
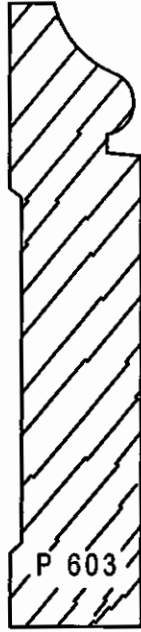
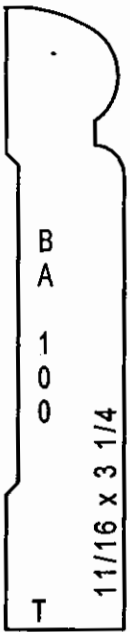

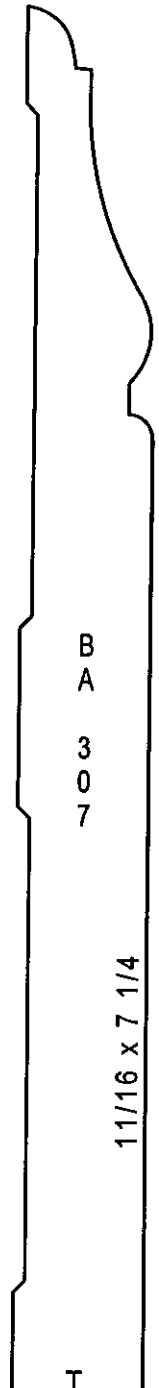
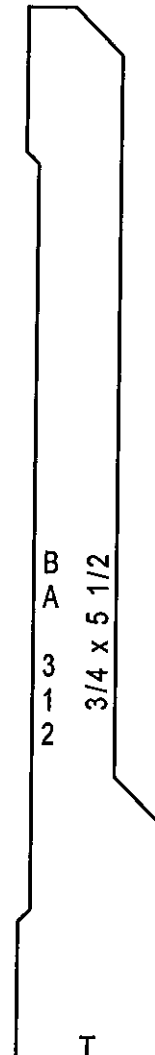
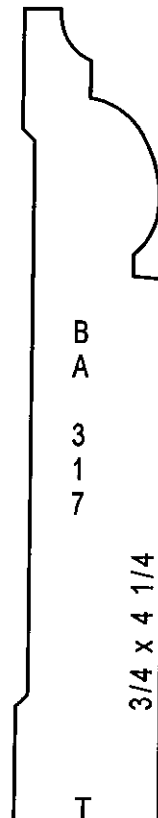
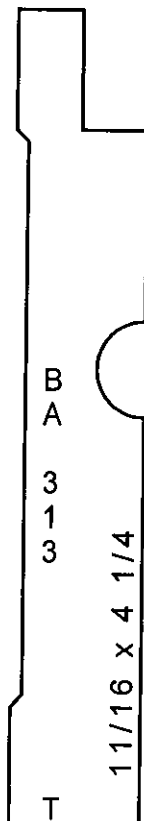
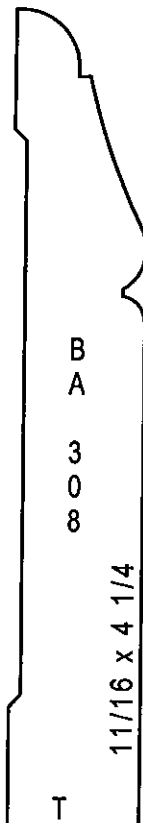
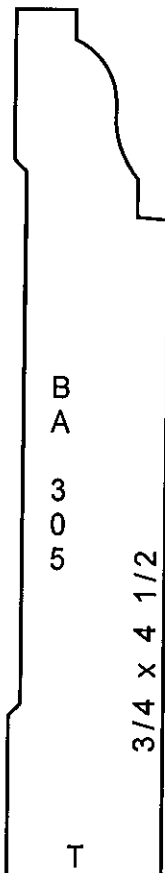
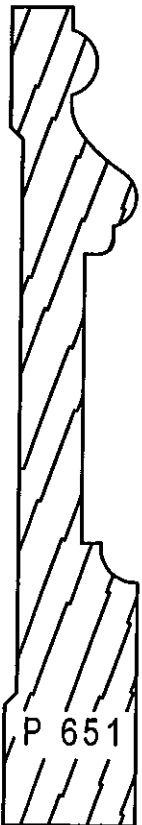
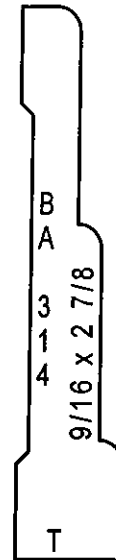
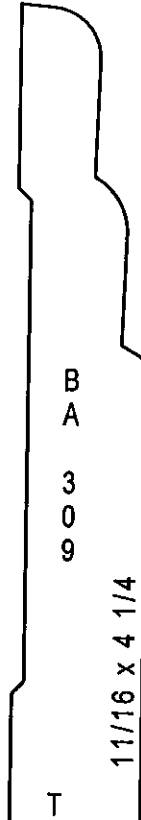
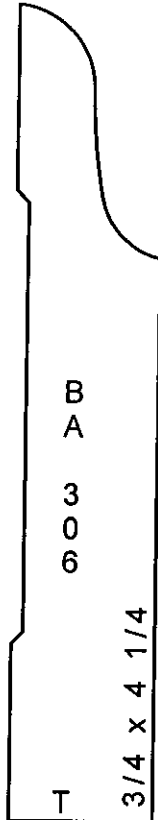
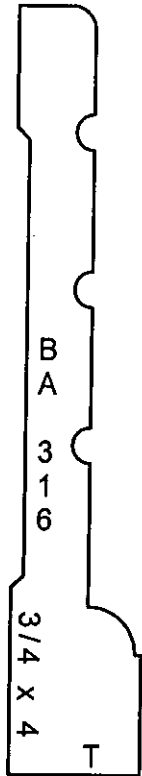
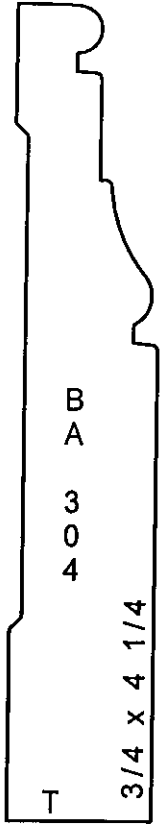

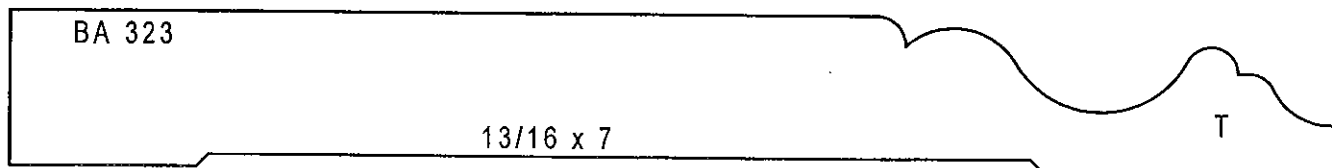
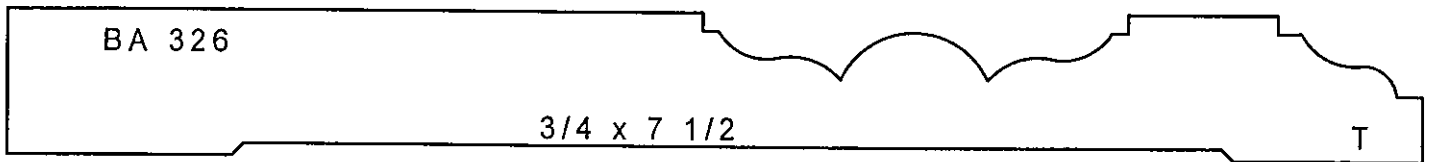
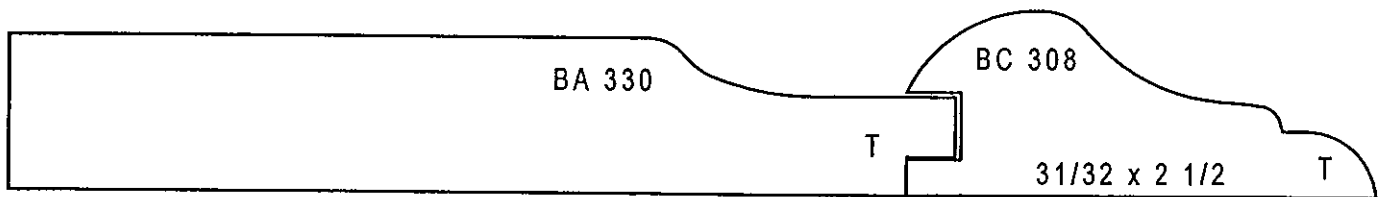
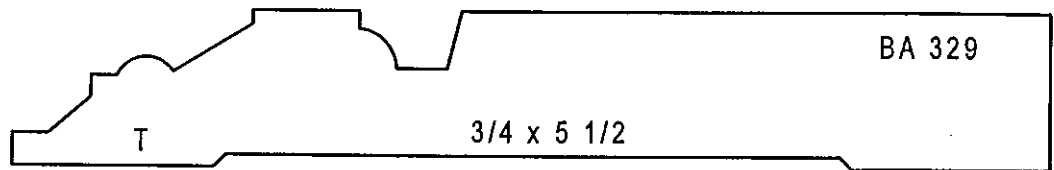
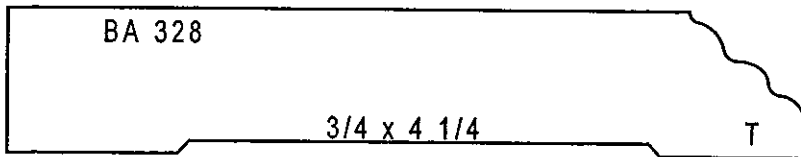
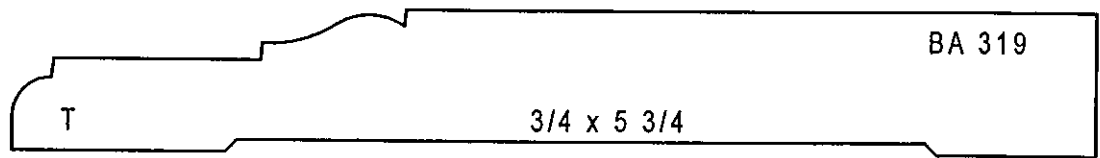
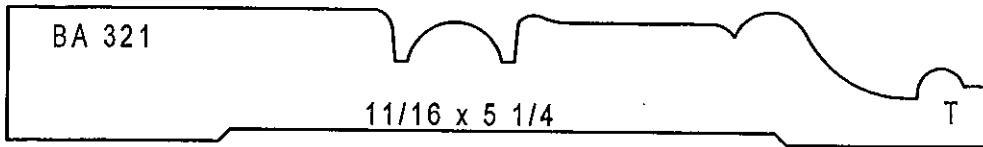
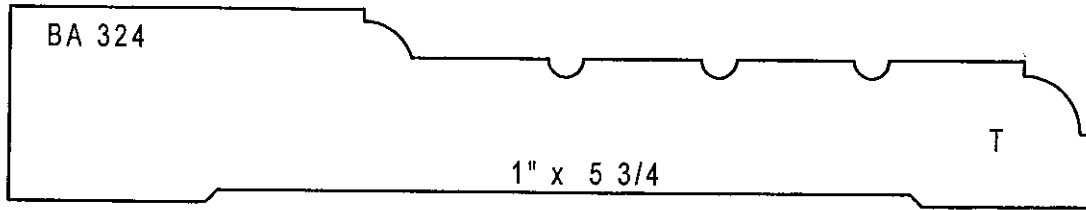

# Casings

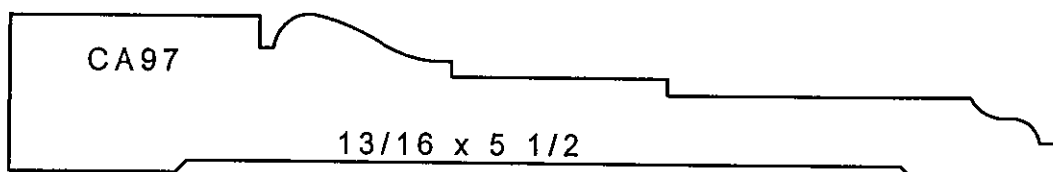
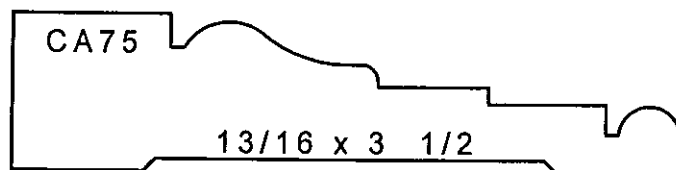
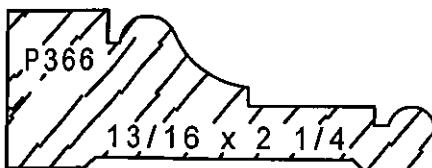
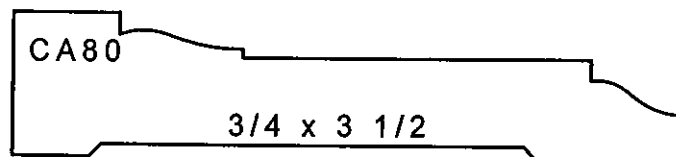
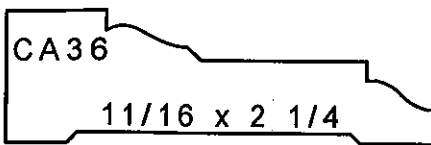
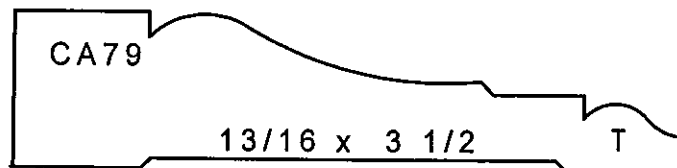
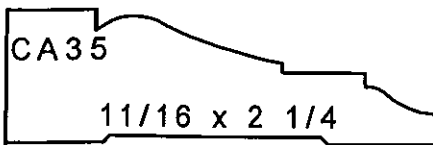
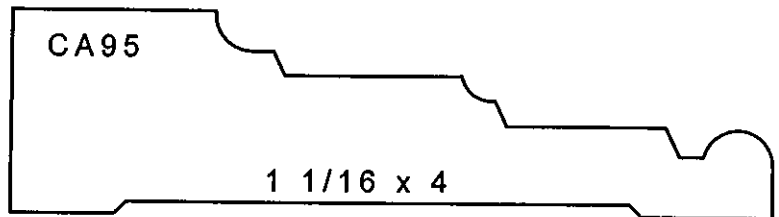
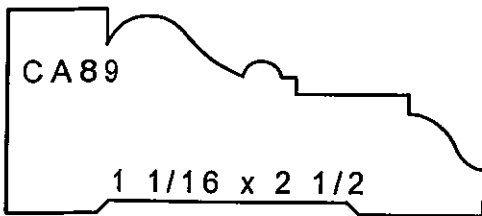
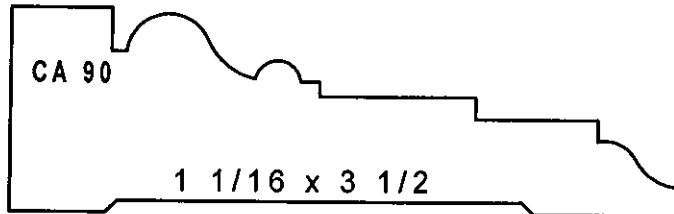
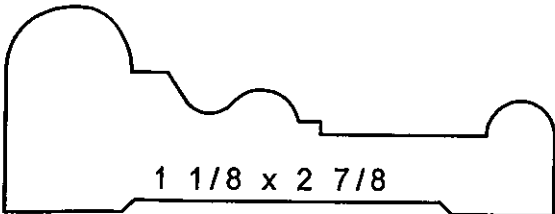
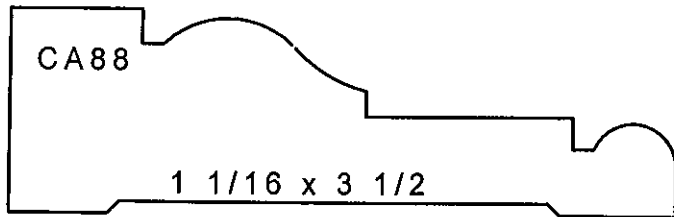
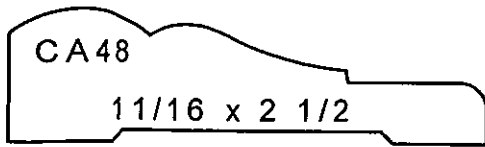

# Casings

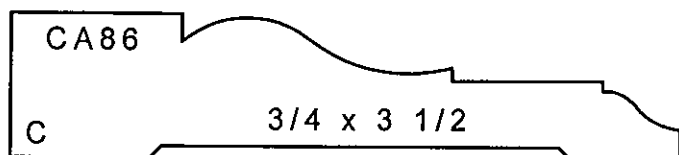
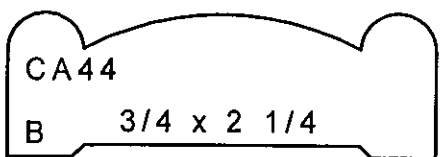
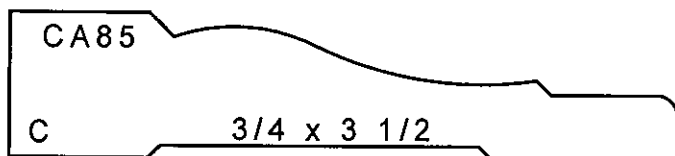
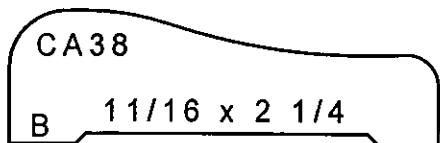
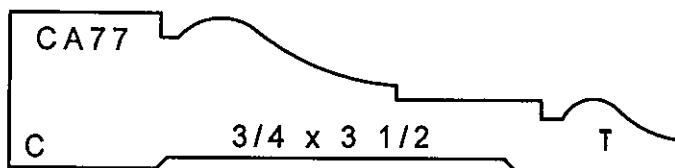
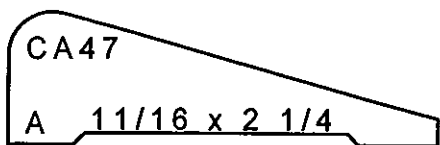
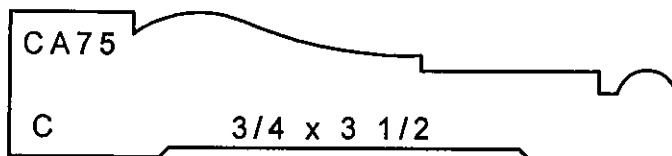
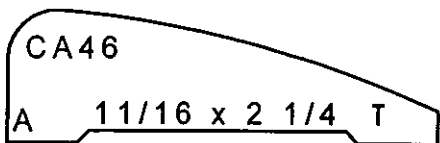
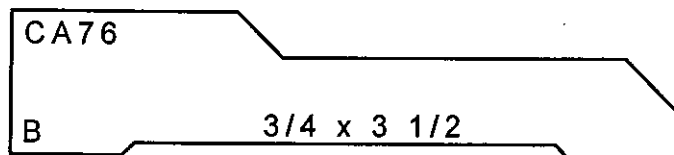
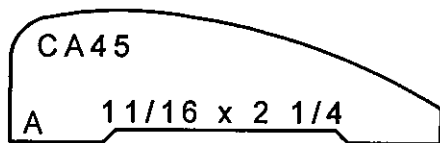
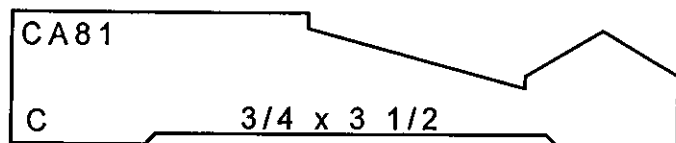
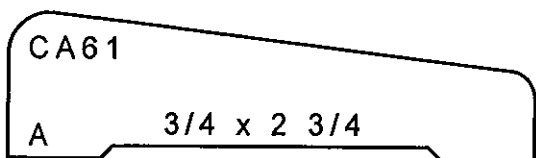
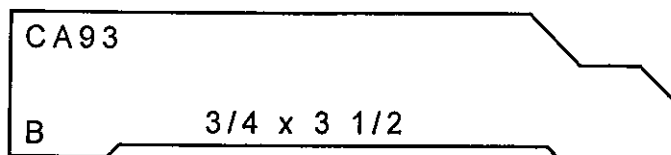
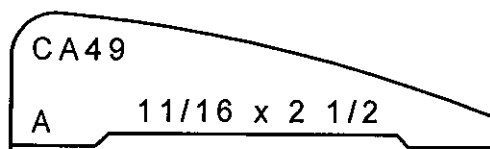

# Casings

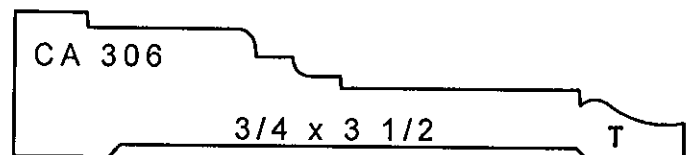
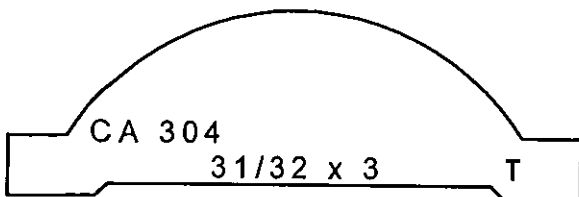
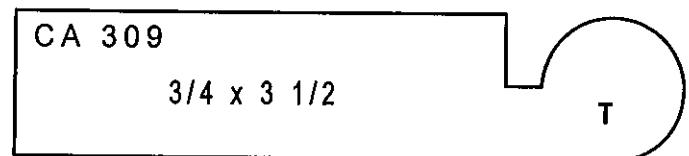
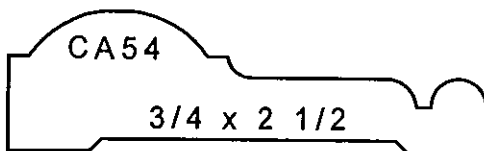
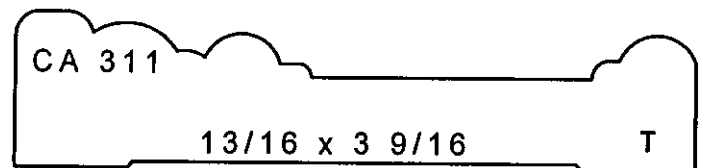
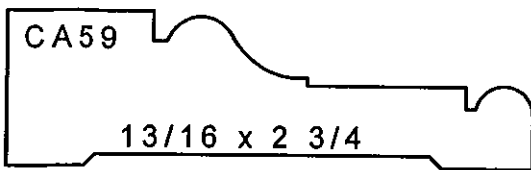
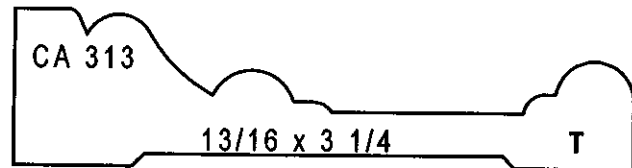
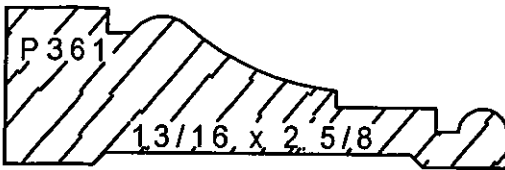
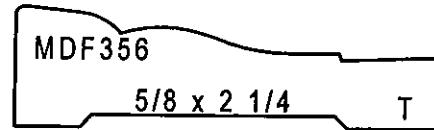
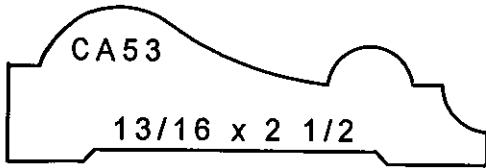
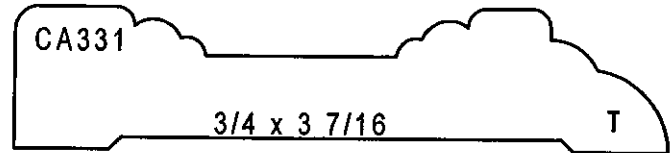
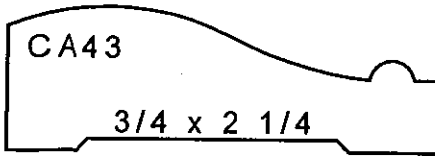
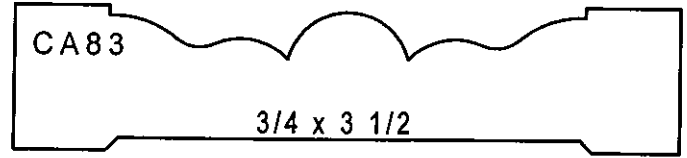
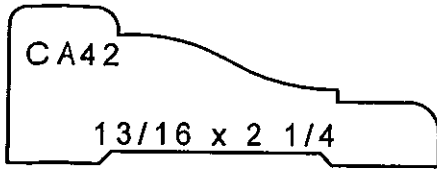

# Casings

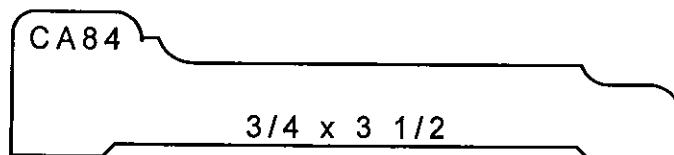
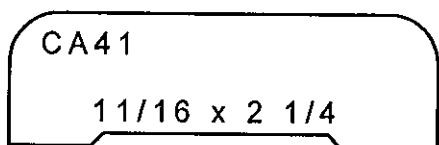
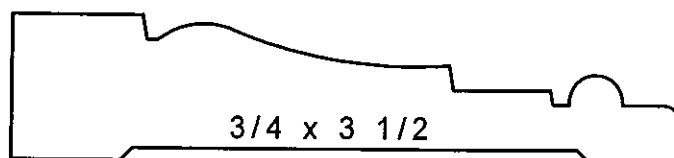
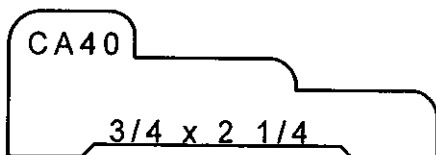
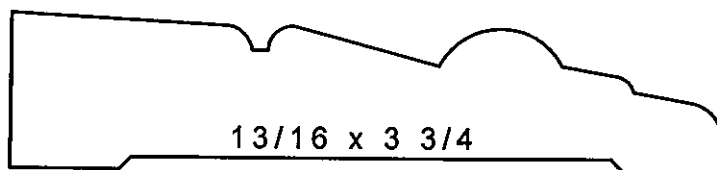
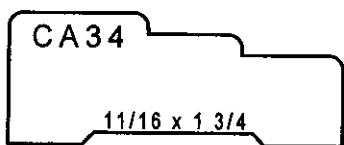
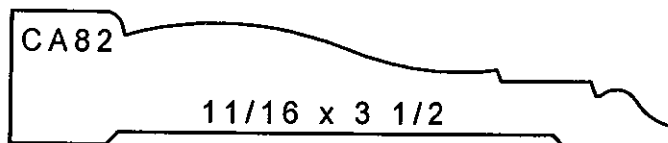
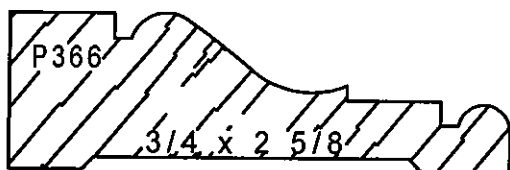
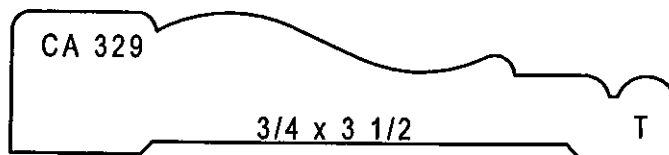
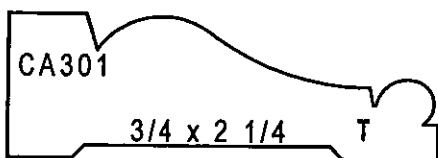
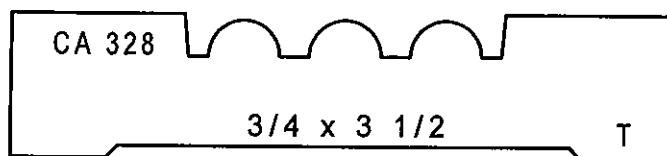
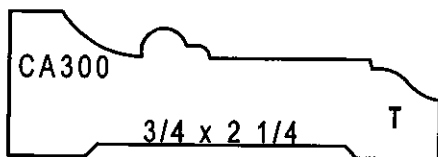
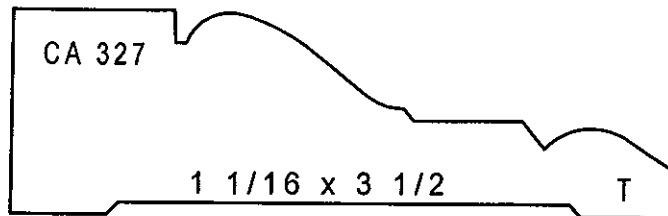
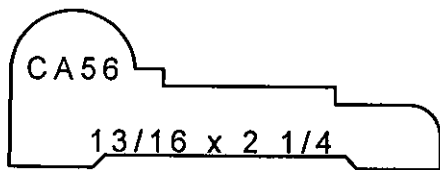



# Casings

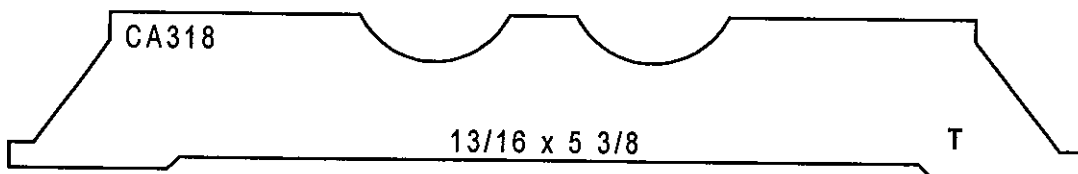
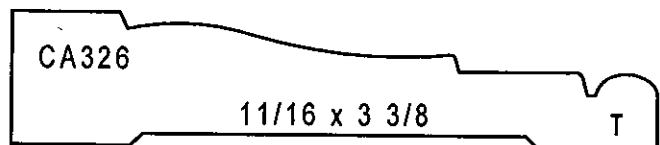
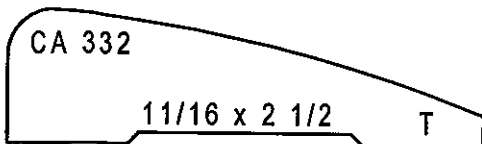
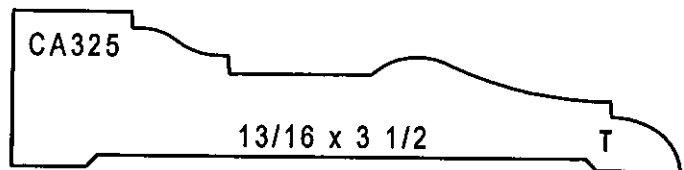
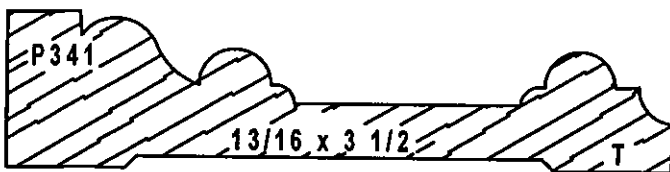
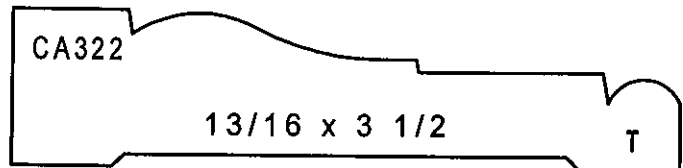
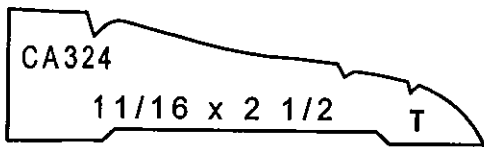
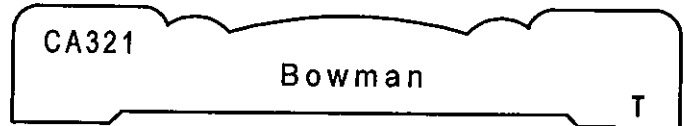
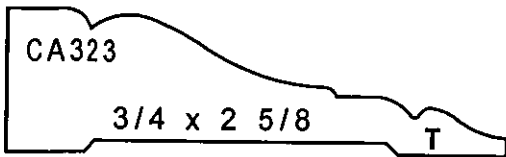
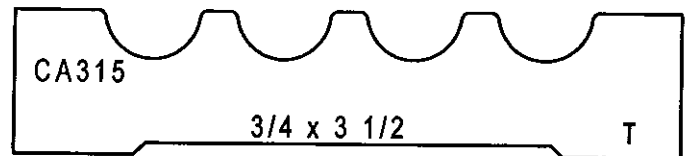
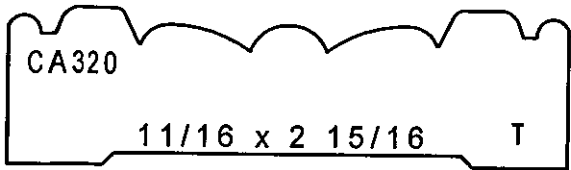
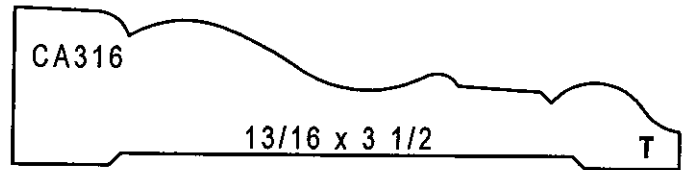
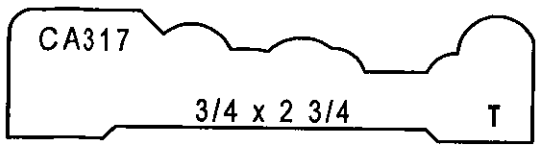

# Casings

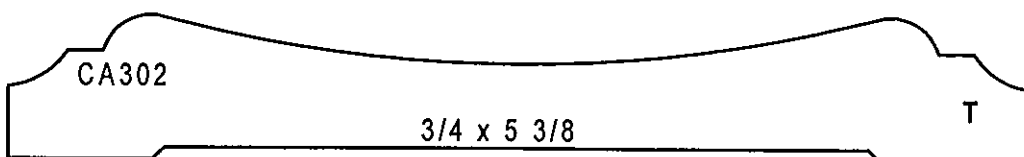
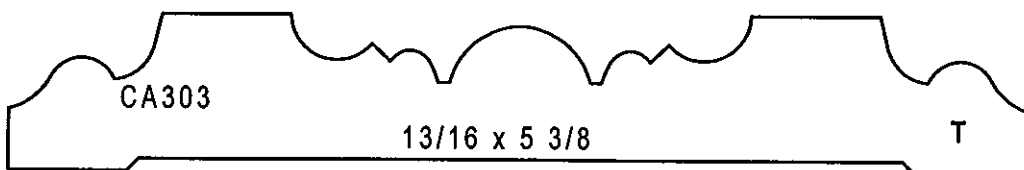
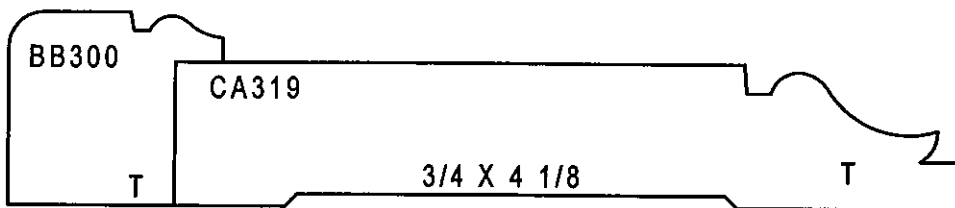
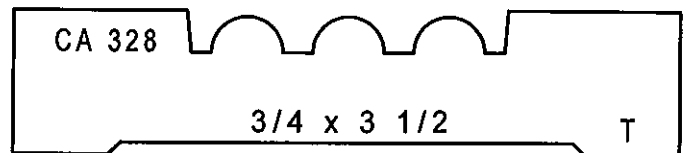
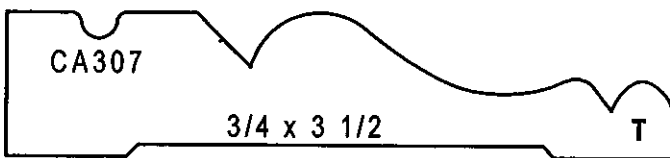
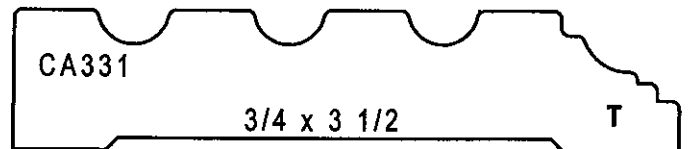
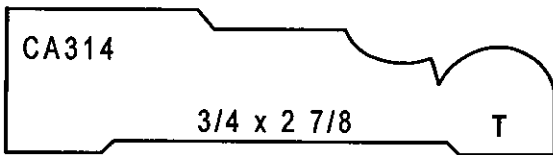
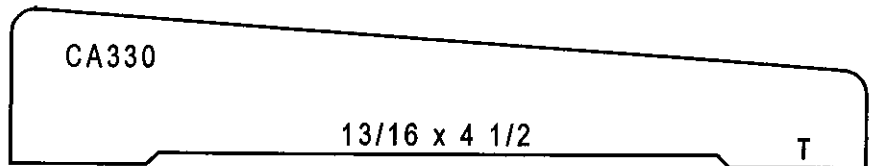
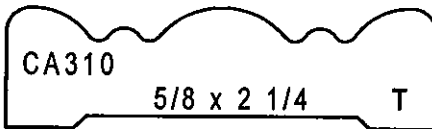
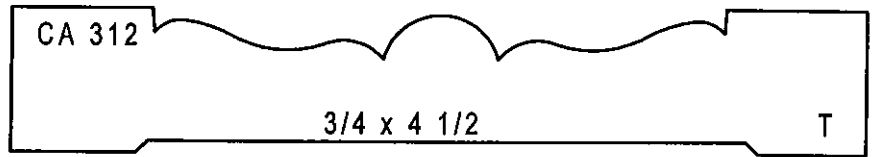
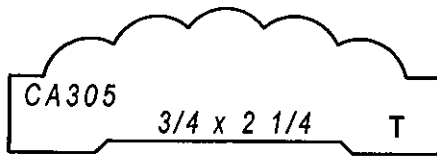

# Casings

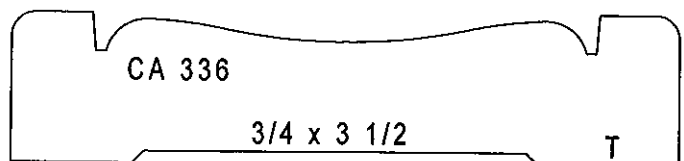
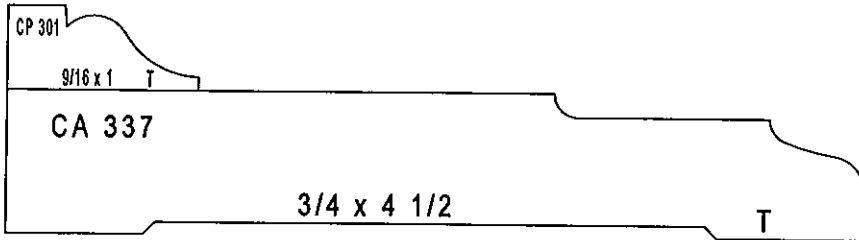
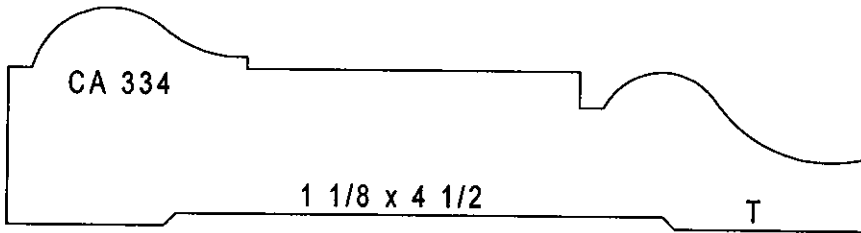
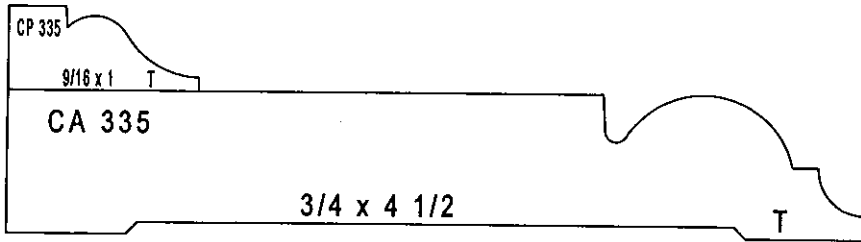
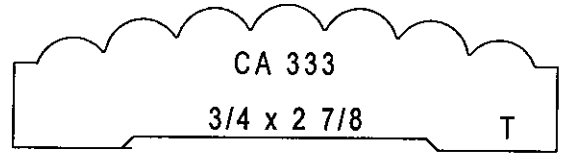
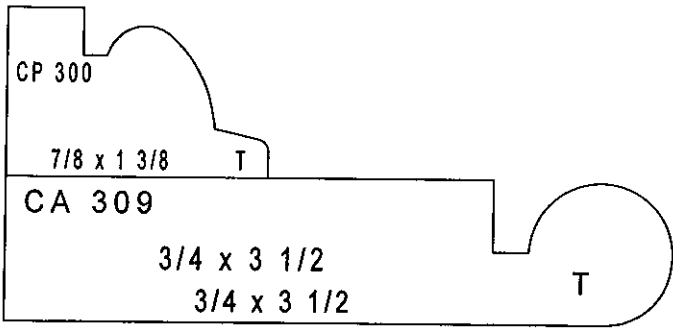

# Casings

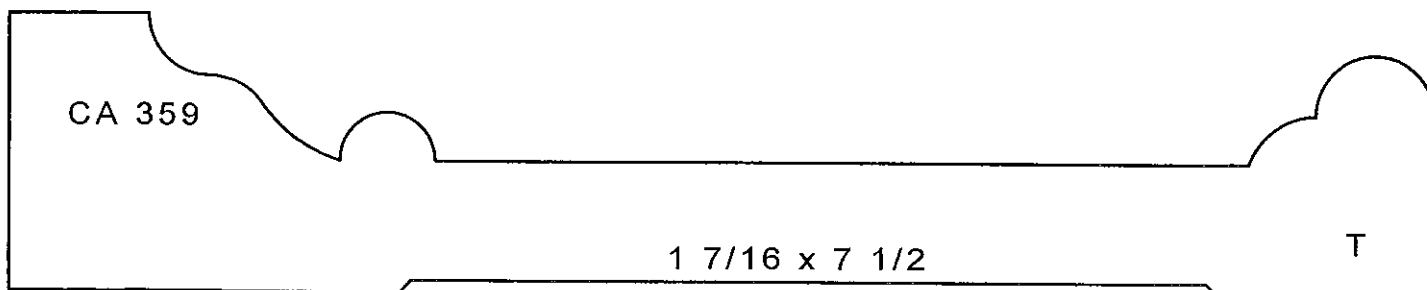
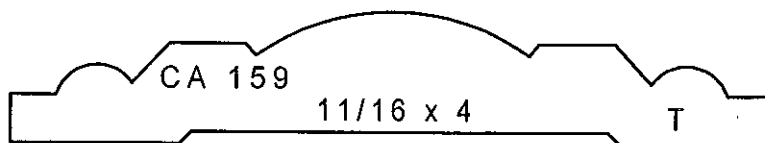
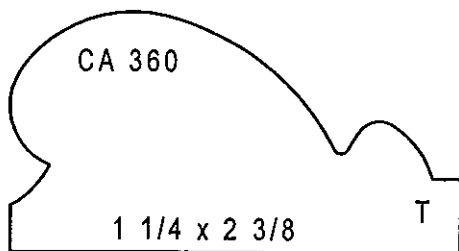
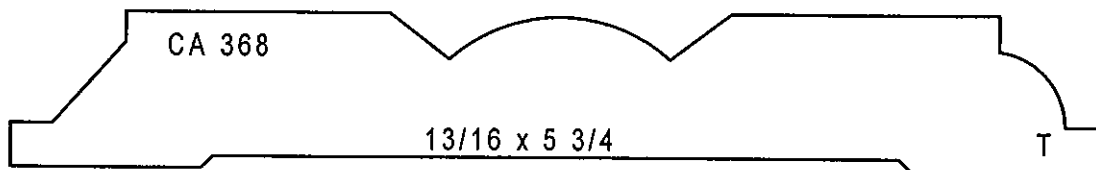
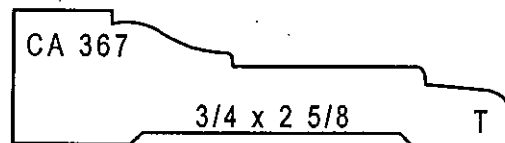
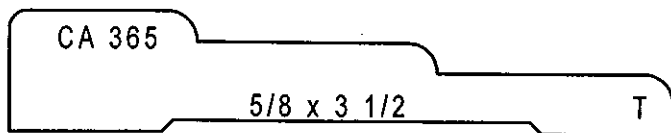
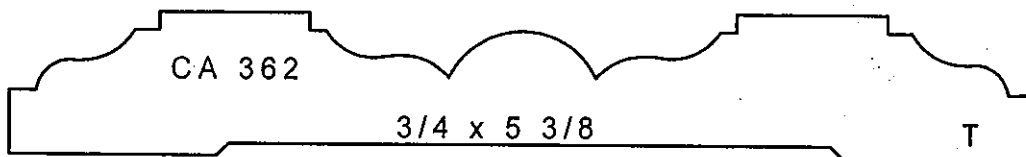
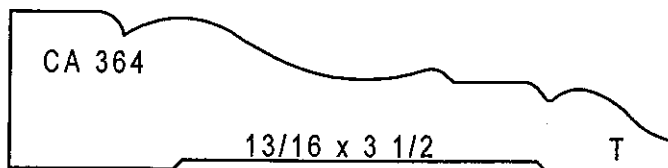
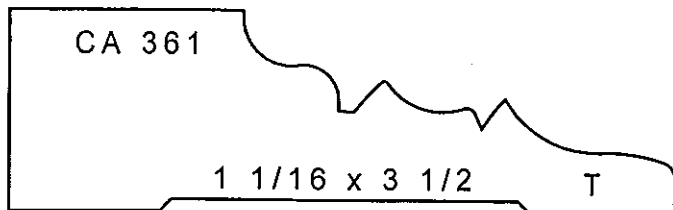
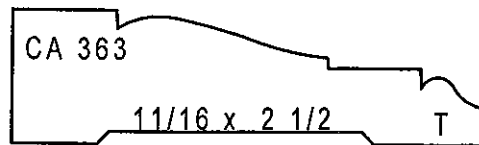
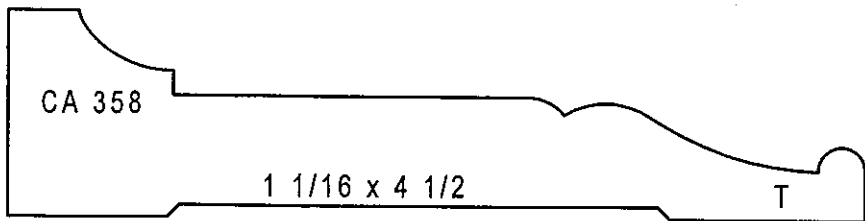

# Base Caps

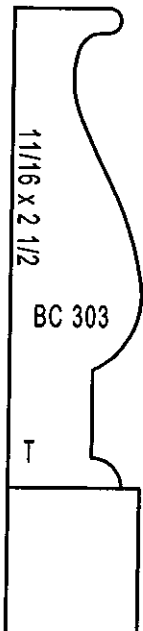
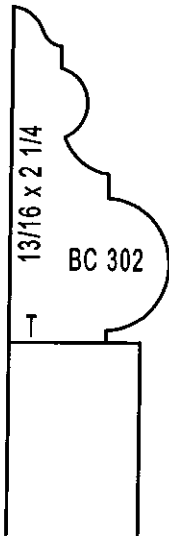
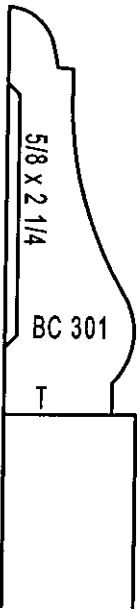
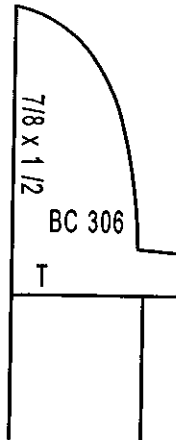
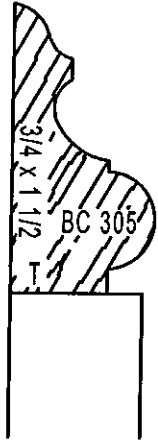
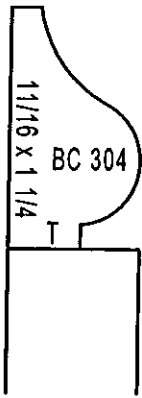
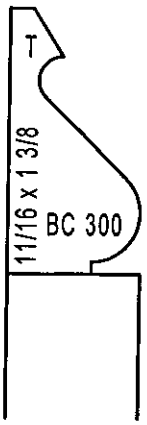

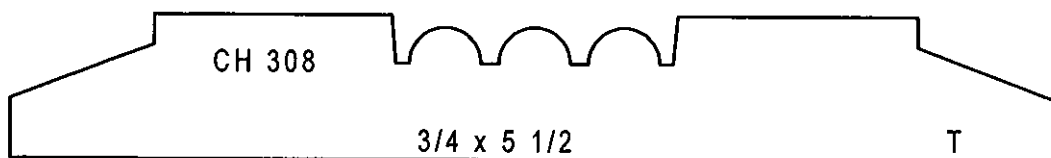
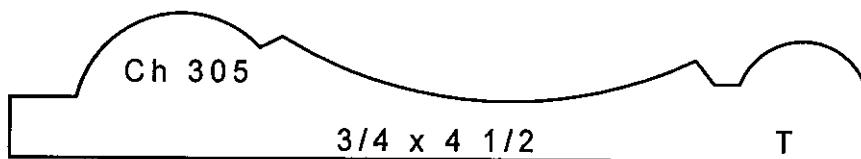
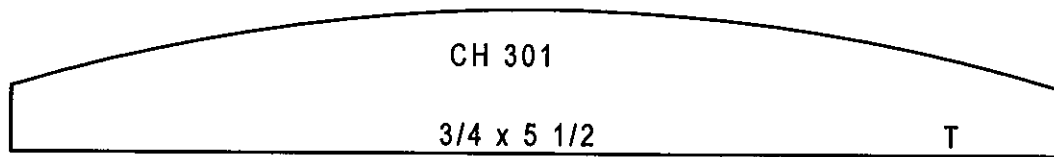
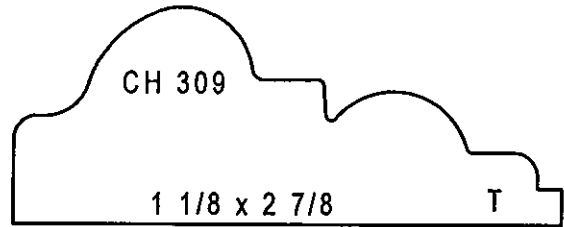
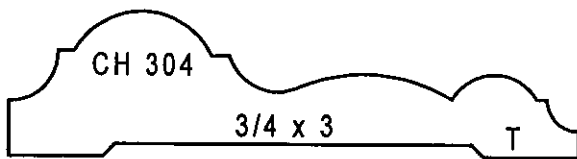
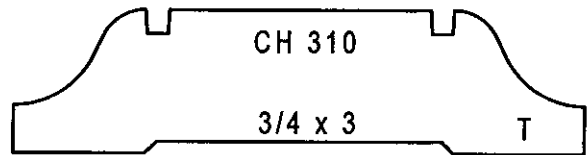
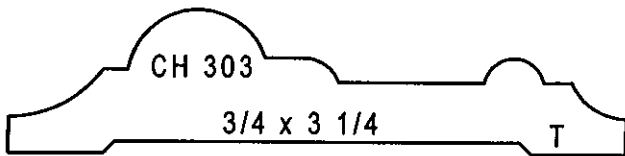
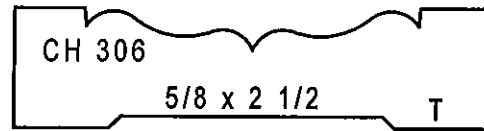
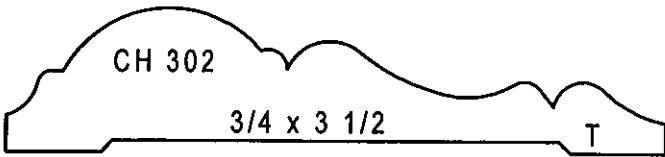
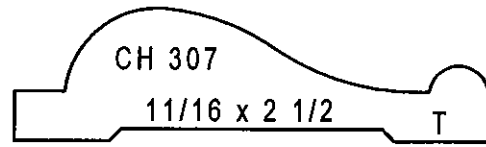
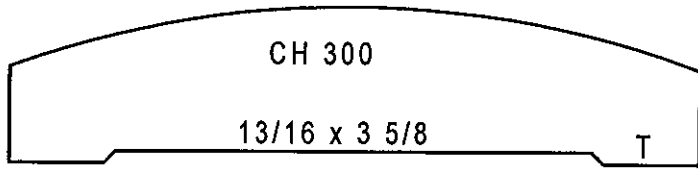

# Coves

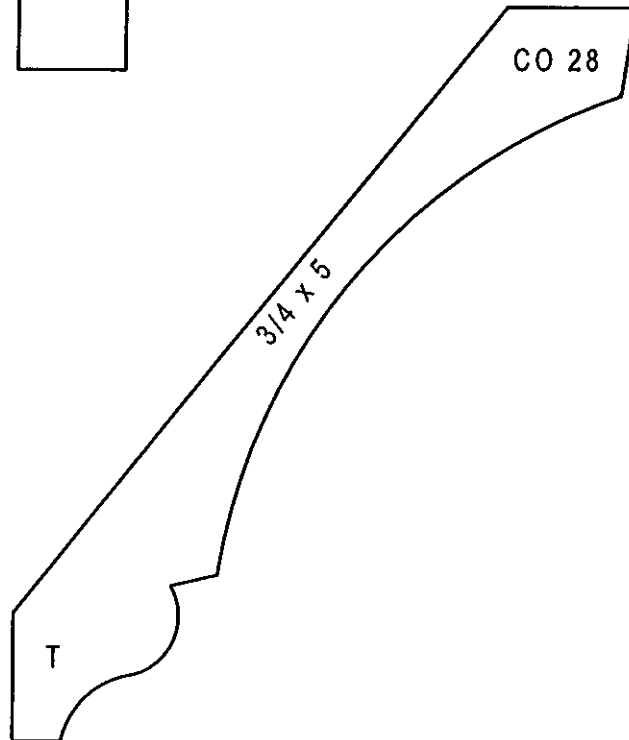
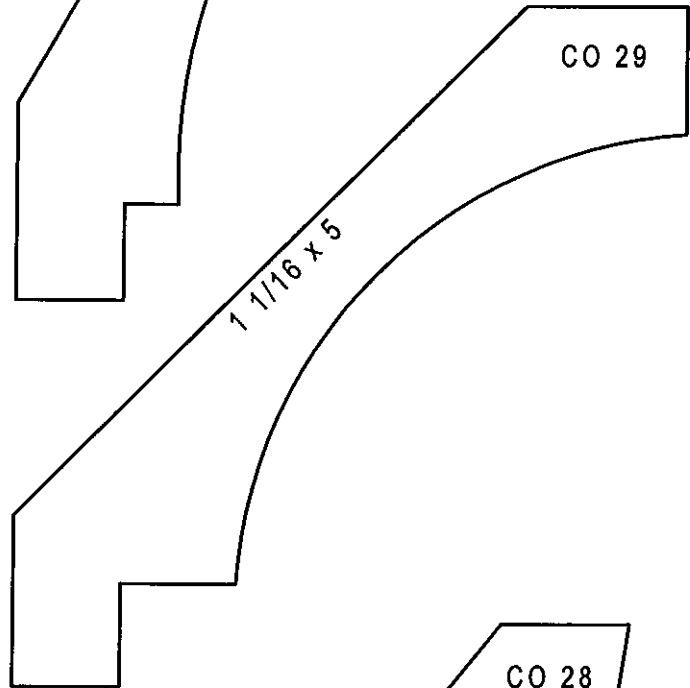
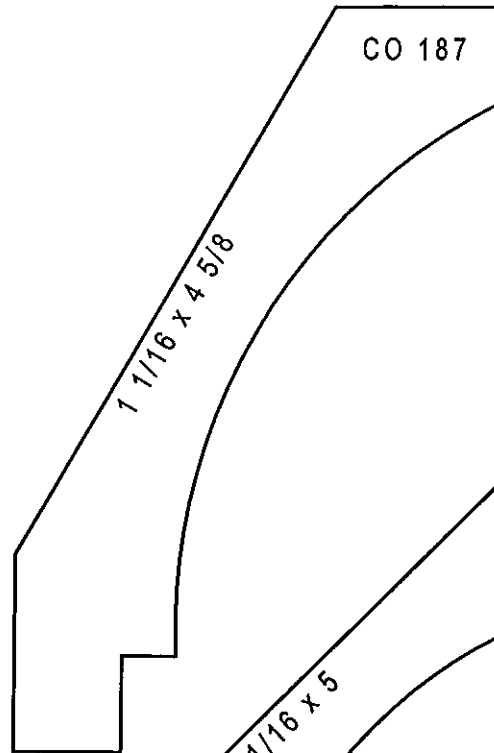
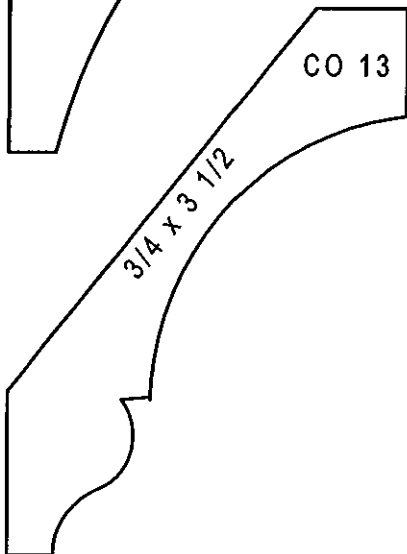
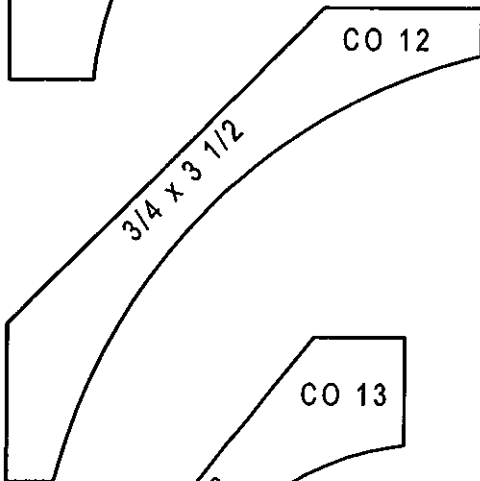
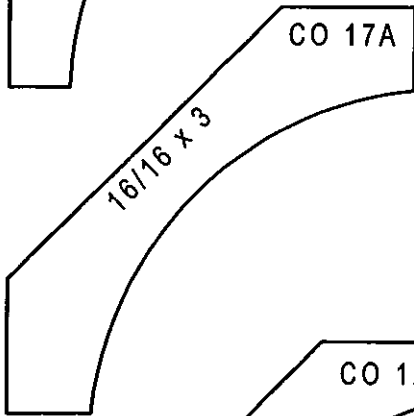
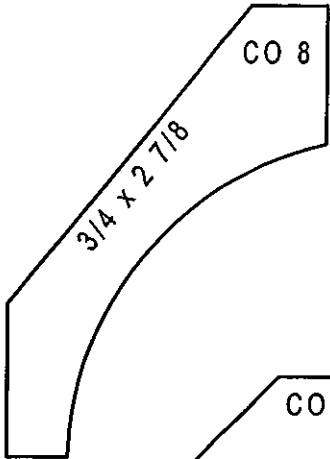
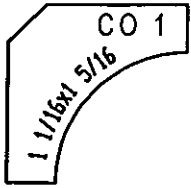

# Crowns

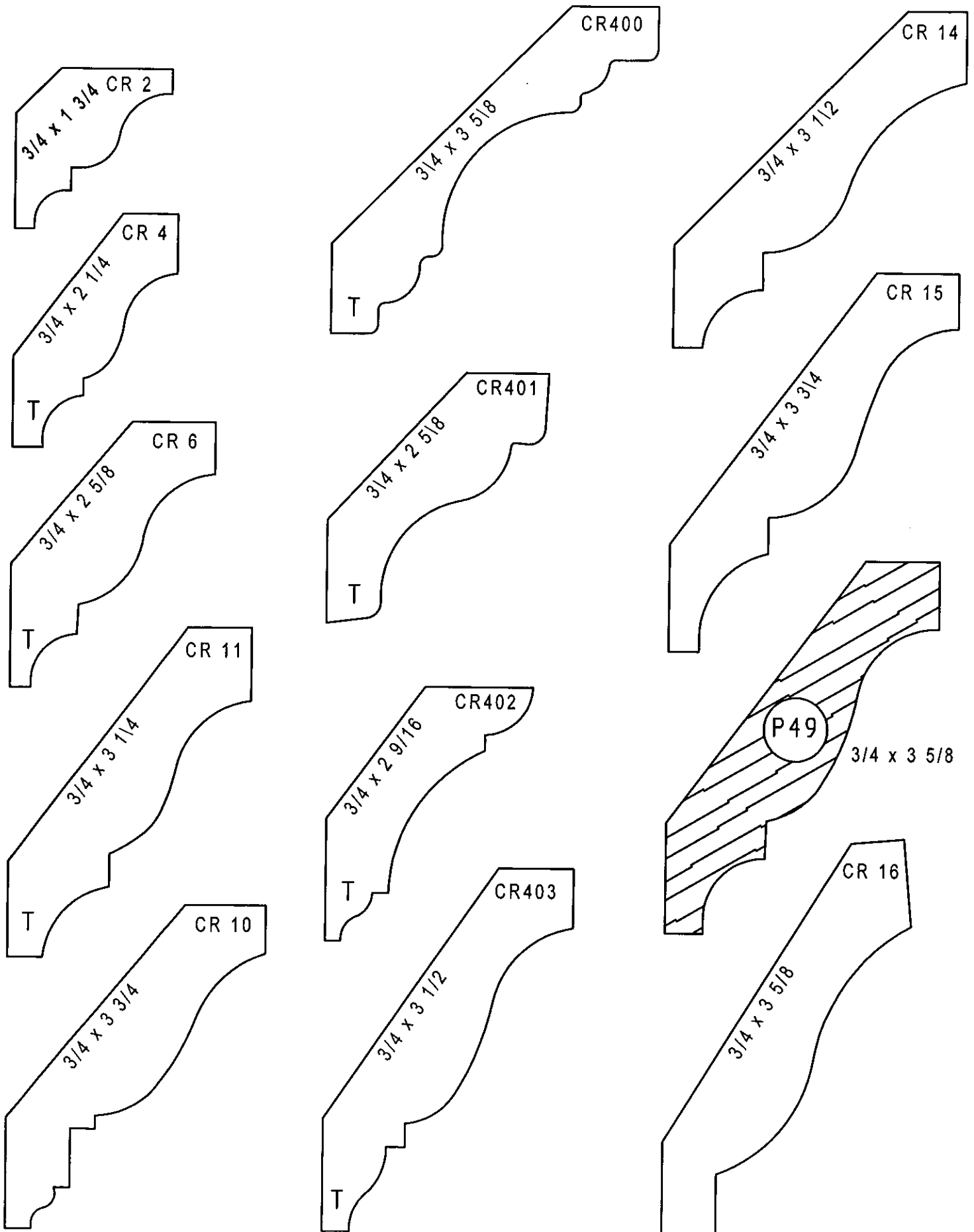



# *Crowns*

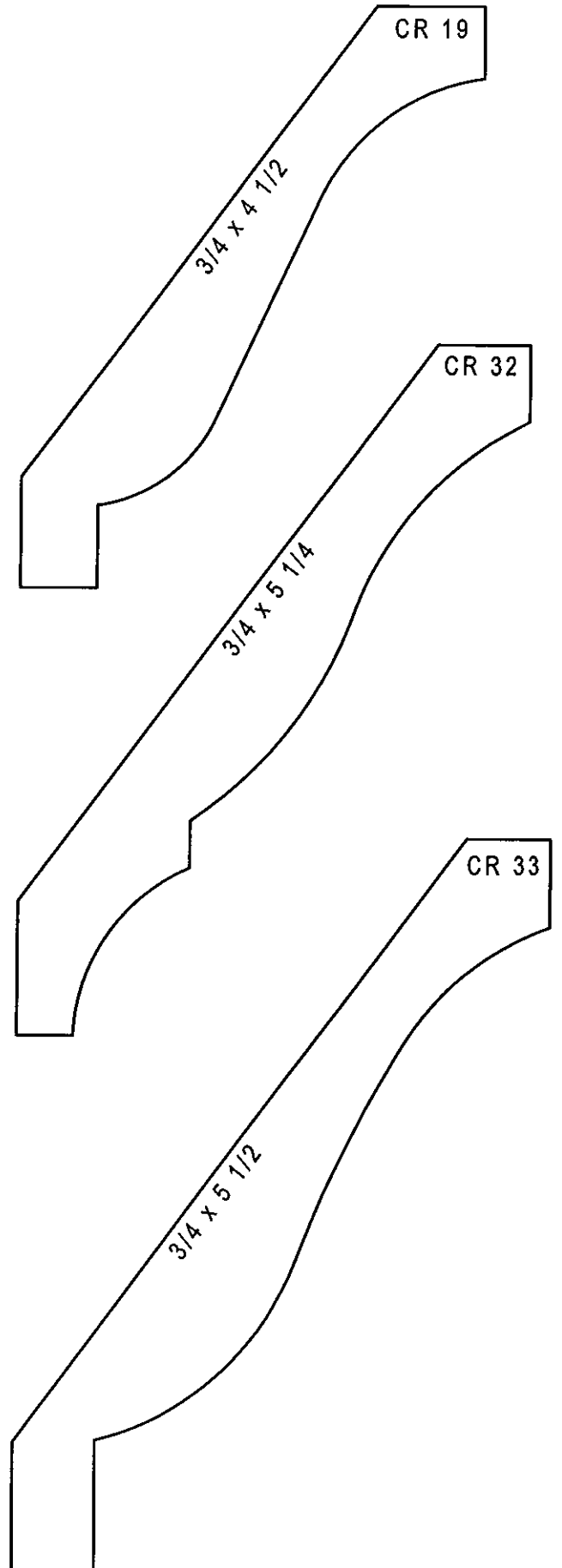
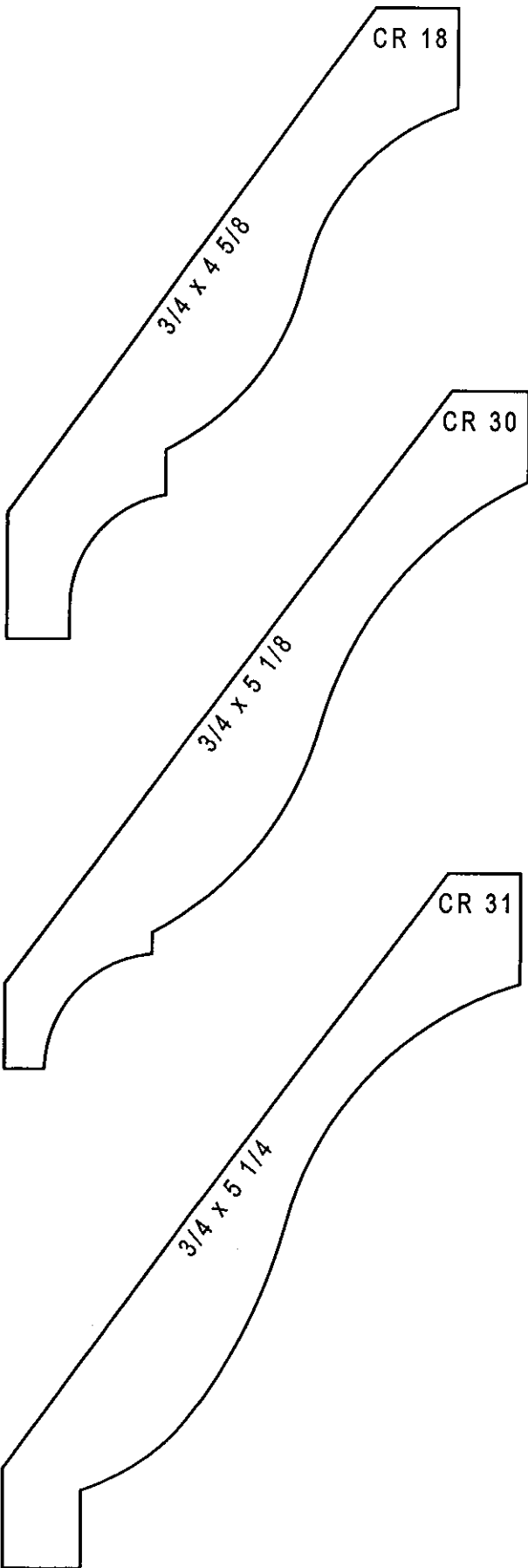

# Crowns

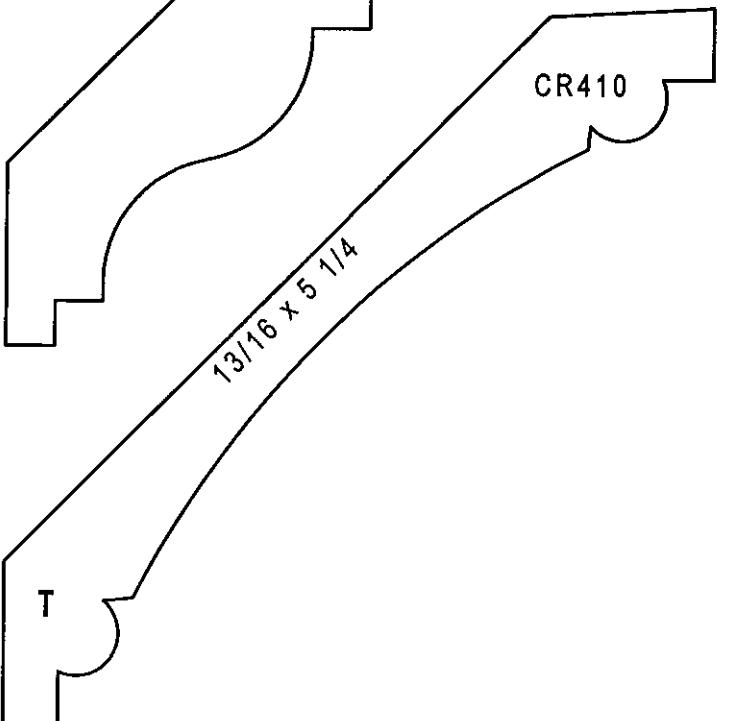
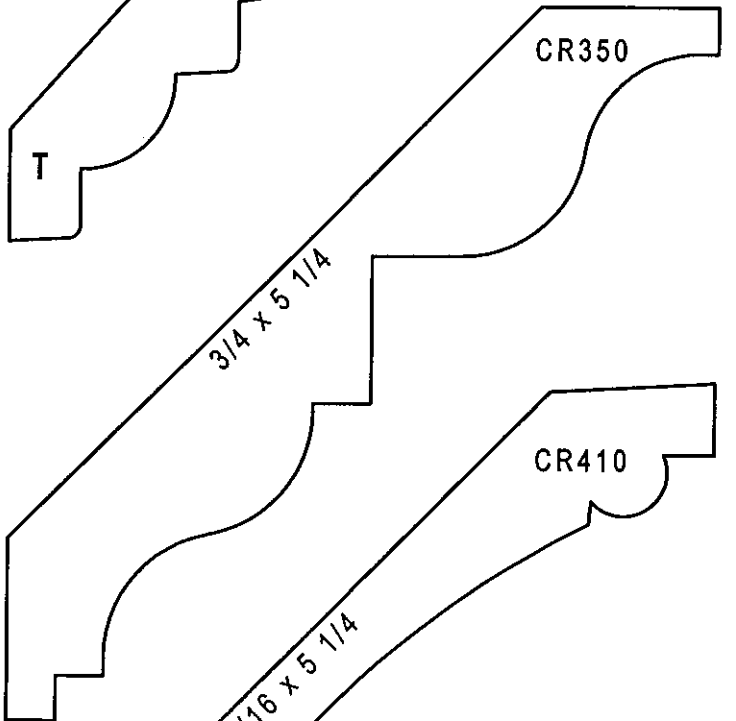
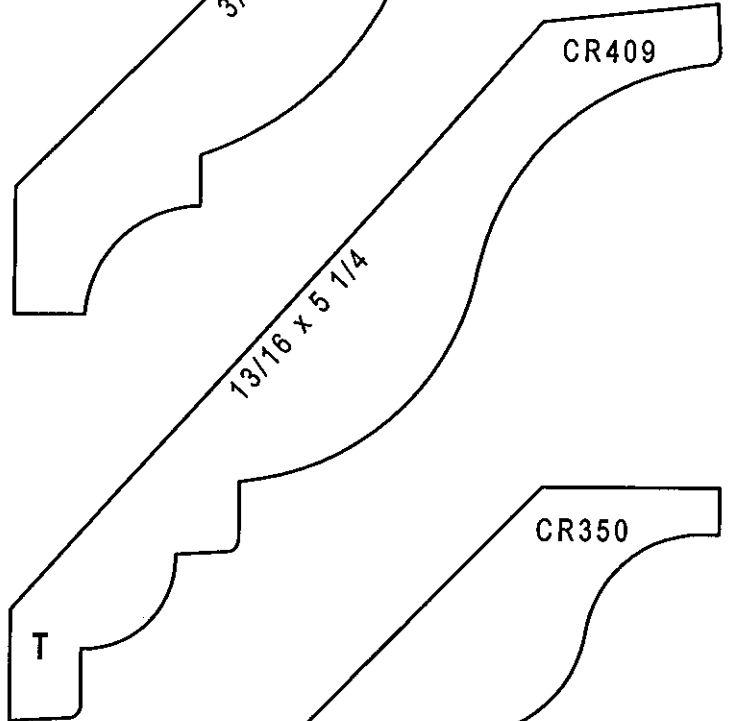
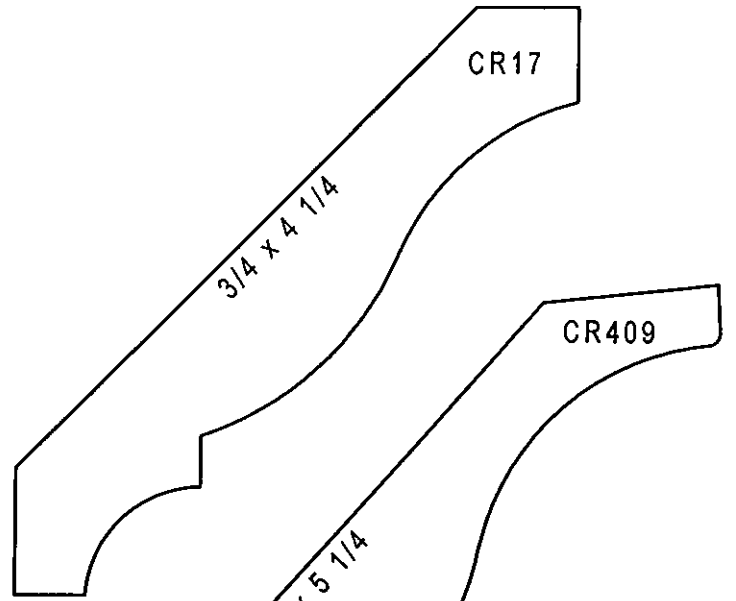
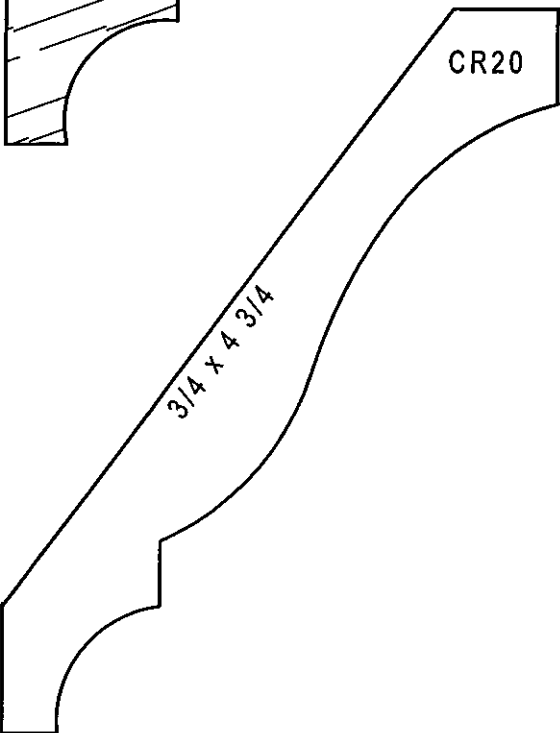
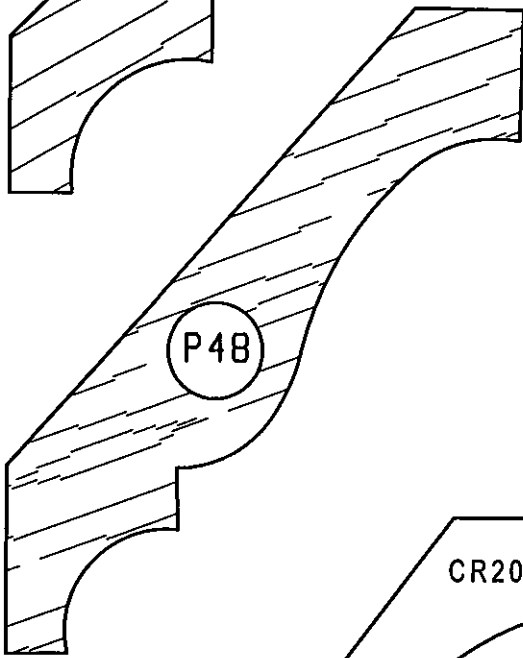
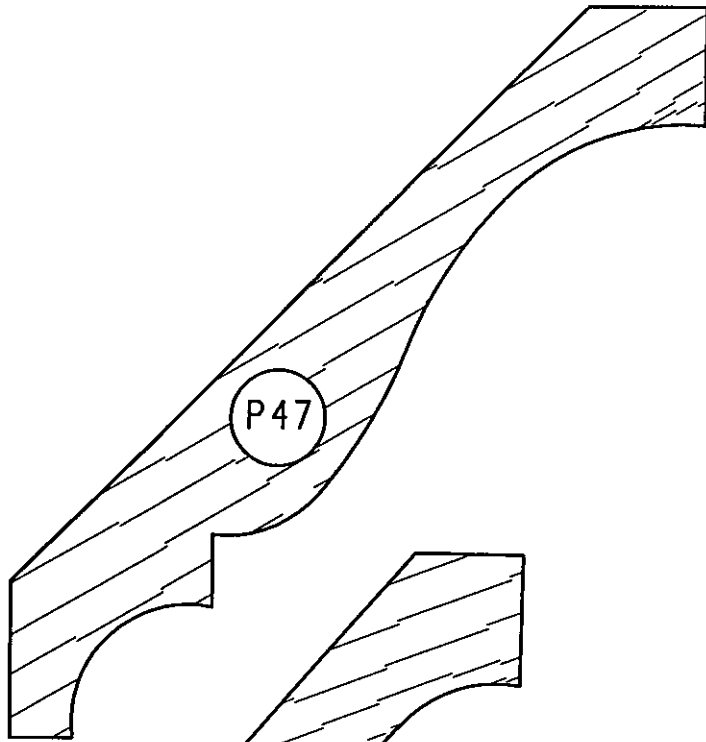

# Crowns

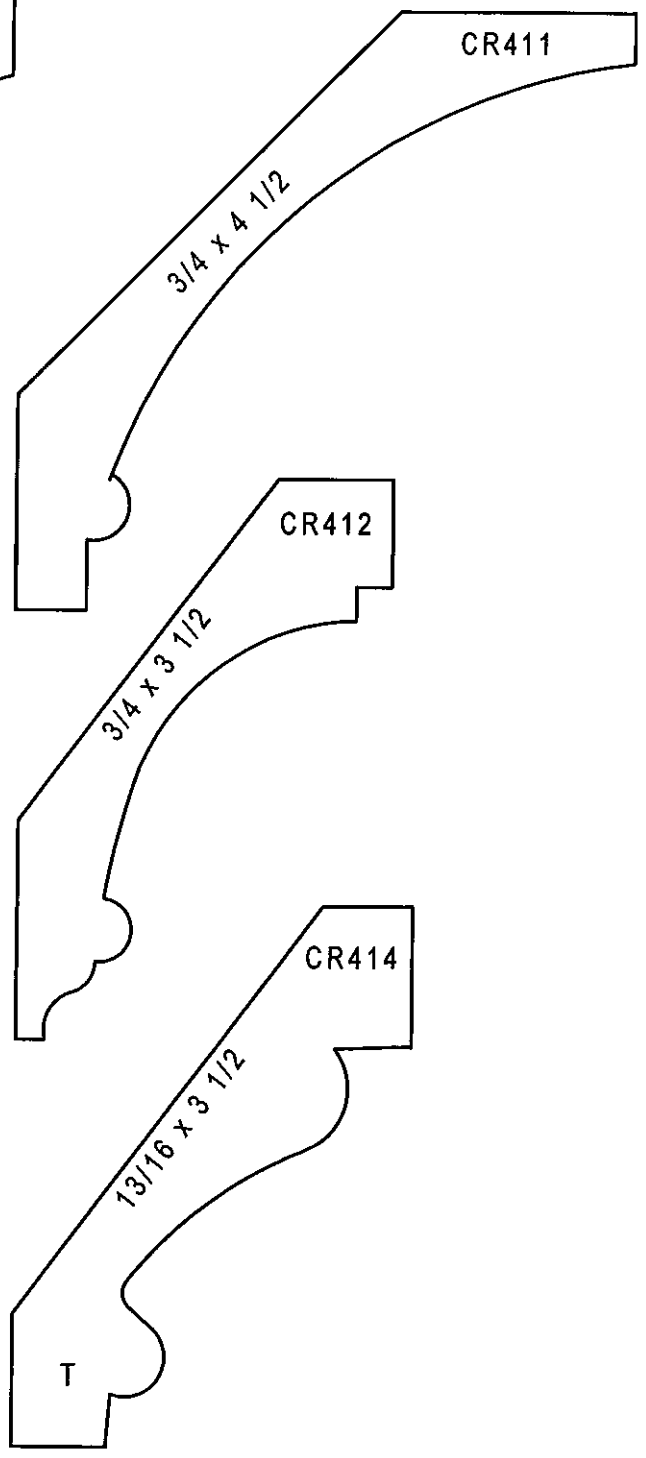
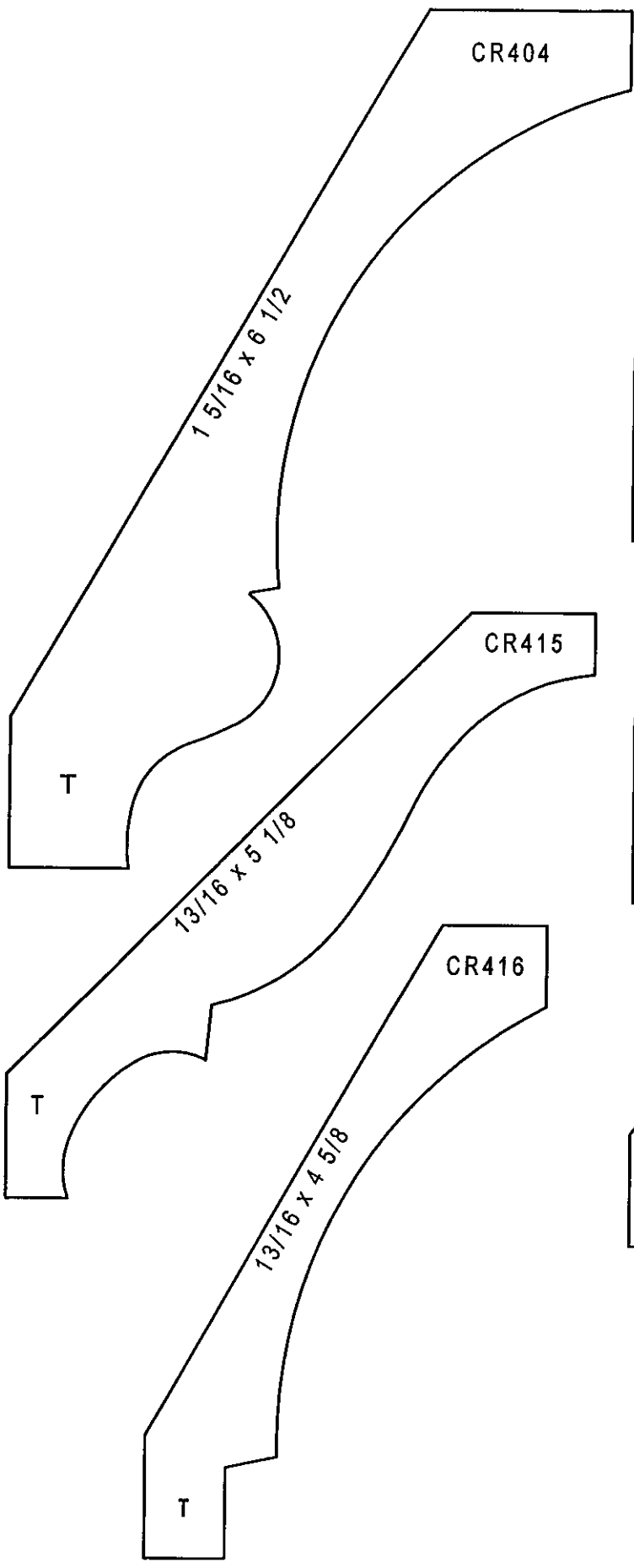

# Crowns

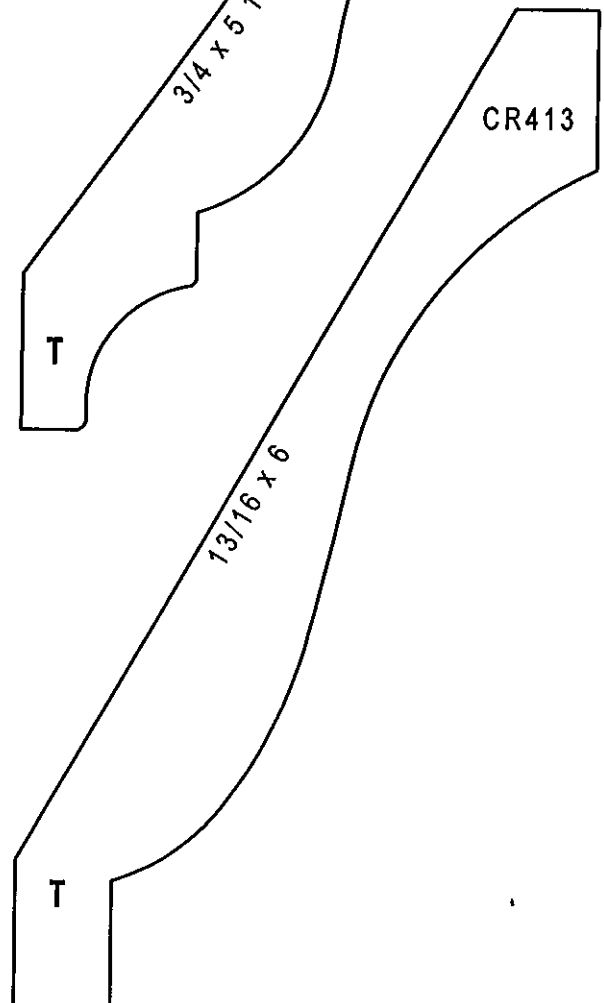
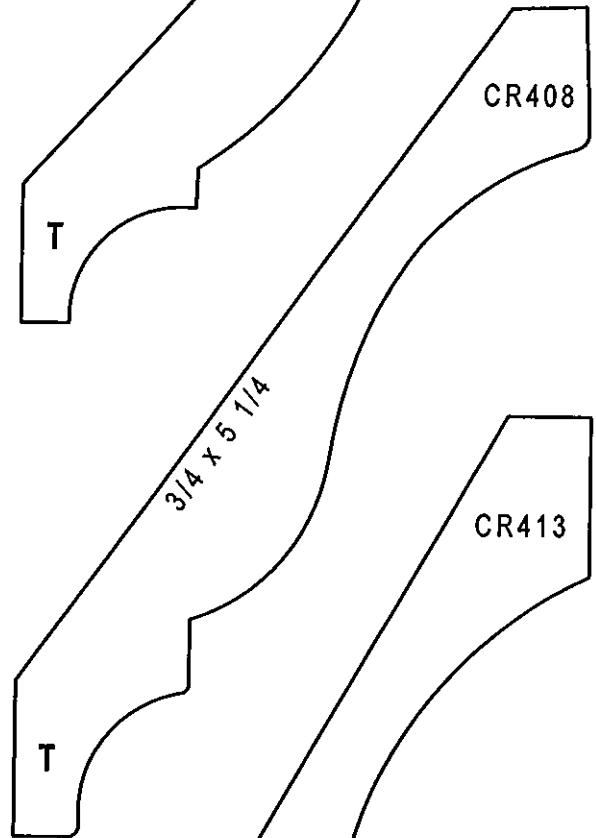
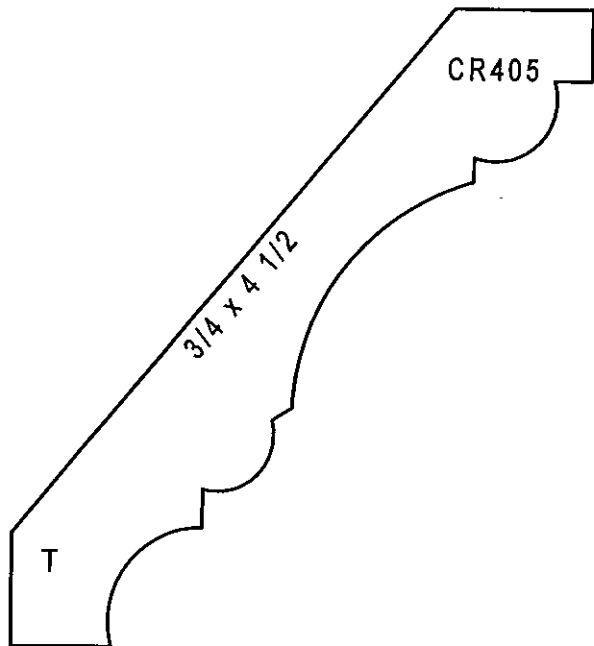
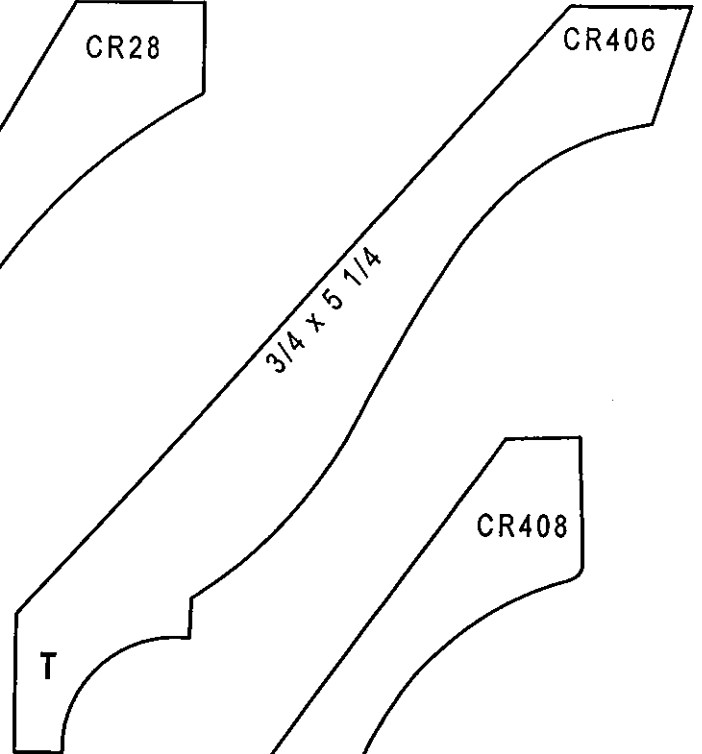
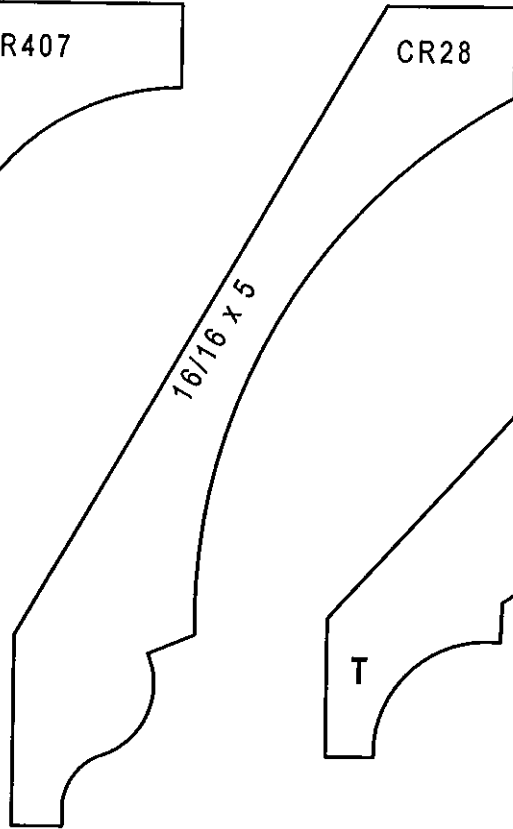
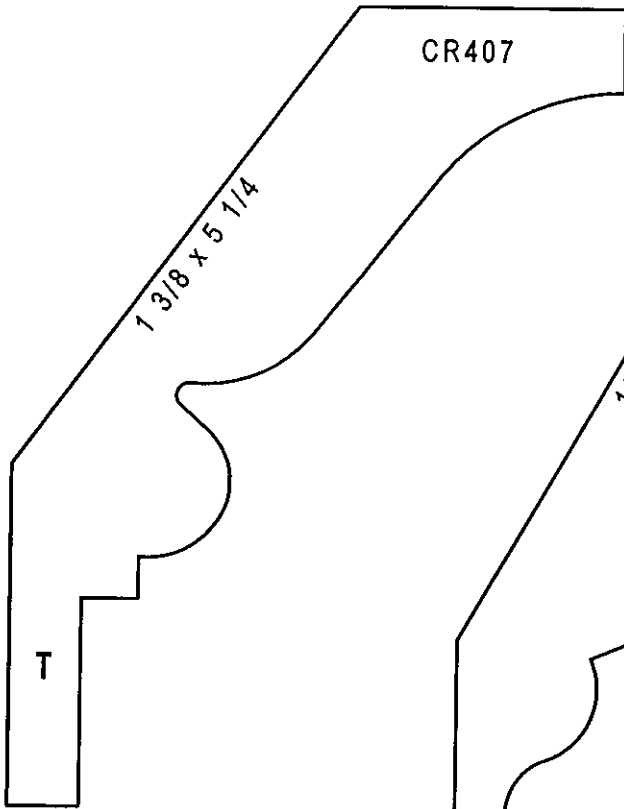

# *Crowns*

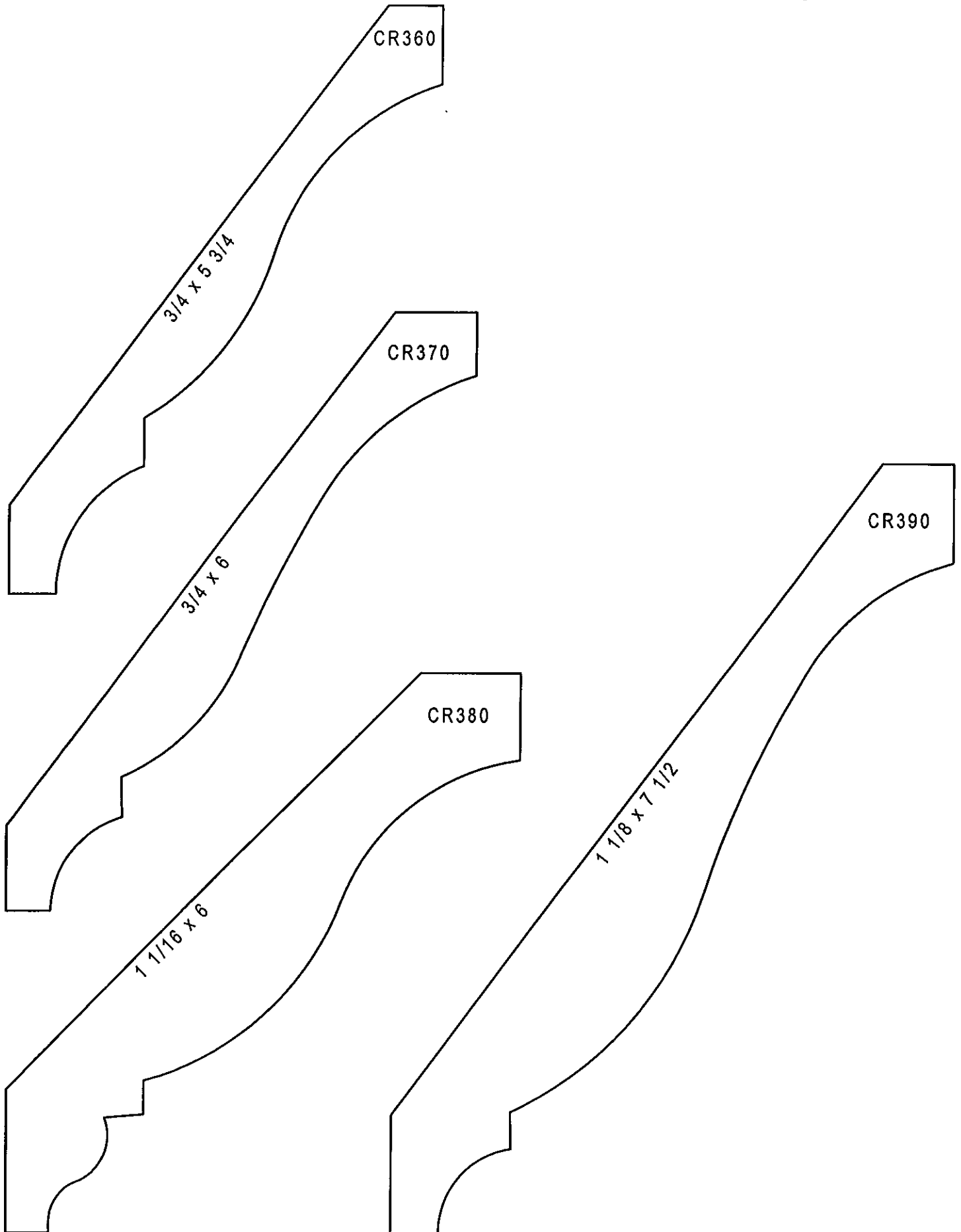

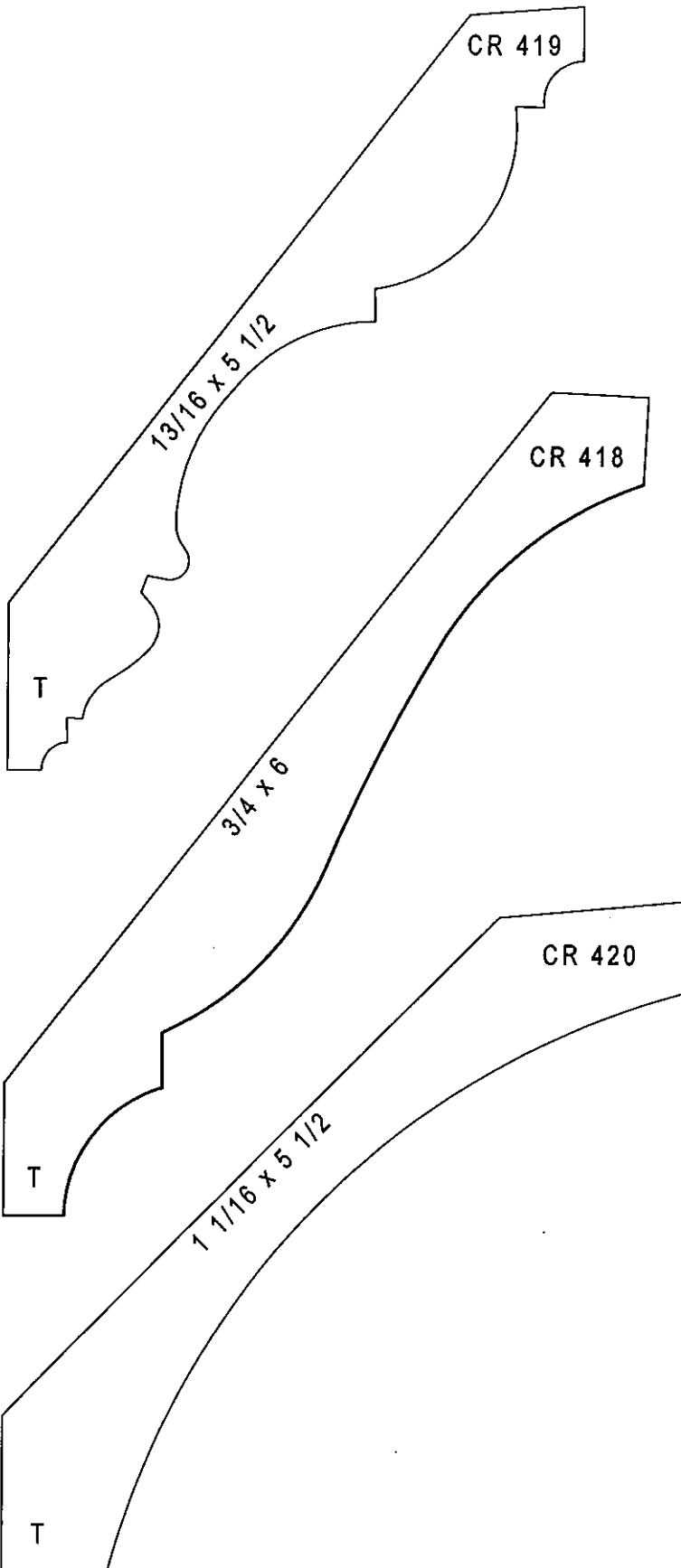

# Panel and Beads

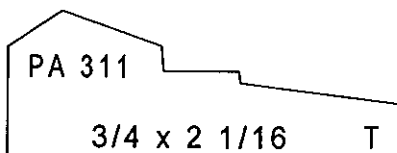
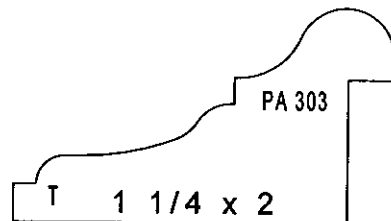
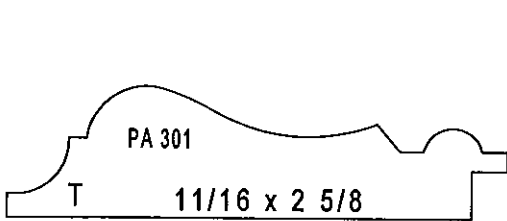
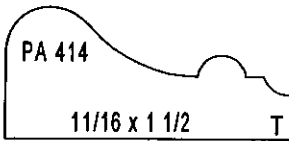
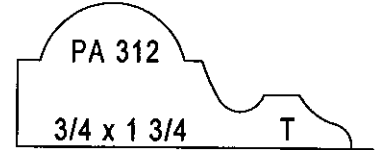
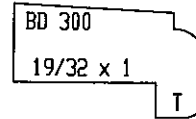
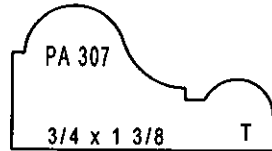
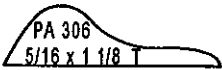
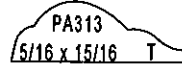
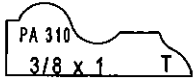
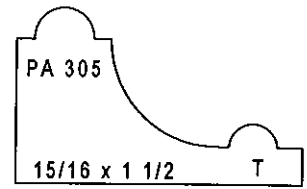
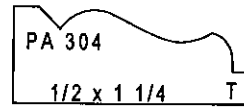
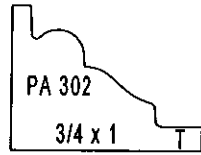
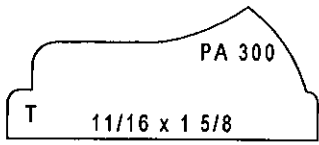

# Back Bands

